



MIC5321

Dual, High Performance
150mA μ Cap ULDO™

General Description

The MIC5321 is a tiny Dual Ultra Low-Dropout (ULDO™) linear regulator ideally suited for those applications that require high PSRR because it provides a bypass pin for those noise sensitive portable electronics. The MIC5321 integrates two high-performance; 150mA ULDOs into a very compact 1.6mm x 1.6mm leadless Thin MLF® package that provides exceptional thermal package characteristics.

The MIC5321 is a μ Cap design which enables operation with very small ceramic output capacitors for stability, thereby reducing required board space and component cost. The combination of extremely low-drop-out voltage, very high power supply rejection, very low output noise and exceptional thermal package characteristics makes it ideal for powering RF application, cellular phone camera modules, imaging sensors for digital still cameras, PDAs, MP3 players and WebCam applications.

The MIC5321 ULDO™ is available in fixed-output voltages in the tiny 6-pin 1.6mm x 1.6mm leadless Thin MLF® package which is only 2.56mm² in area, less than 30% the area of the SOT-23, TSOP and MLF® 3x3 packages. It's also available in the thin SOT-23-6 lead package and the standard 6-pin 1.6mm x 1.6mm leadless package. Additional voltage options are available. For more information, contact Micrel marketing department.

Data sheets and support documentation can be found on Micrel's web site at www.micrel.com.

Features

- 2.3V to 5.5V input voltage range
- Ultra-low dropout voltage ULDO™ 35mV @ 150mA
- Tiny 6-pin 1.6mm x 1.6mm Thin MLF® leadless package
- Low cost TSOT-23-6 package
- Bypass pin for improved noise performance
- High PSRR – >75dB on each LDO
- Ultra low noise output - > 30 μ Vrms
- Dual 150mA outputs
- μ Cap stable with 1 μ F ceramic capacitor
- Low quiescent current – 150 μ A
- Fast turn-on time – 45 μ s
- Thermal shutdown protection
- Current Limit protection

Applications

- Mobile phones
- PDAs
- GPS receivers
- Portable electronics
- Portable media players
- Digital still and video cameras

Typical Application

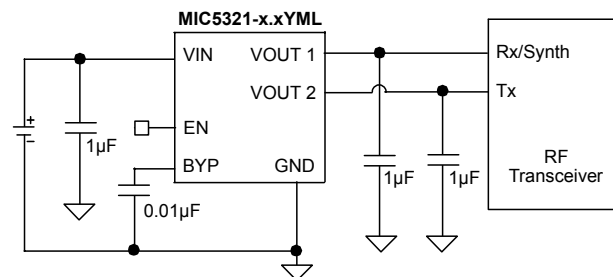

RF Power Supply Circuit

ULDO is a trademark of Micrel, Inc.

MLF and *MicroLeadFrame* are registered trademarks of Amkor Technology, Inc.

Micrel Inc. • 2180 Fortune Drive • San Jose, CA 95131 • USA • tel +1 (408) 944-0800 • fax + 1 (408) 474-1000 • <http://www.micrel.com>

Ordering Information

Part number	Manufacturing Part Number	Marking*	Voltage**	Junction Temp. Range	Package
MIC5321-1.8/1.5YMT	MIC5321-GFYMT	BGF	1.8V/1.5V	-40°C to +125°C	6-Pin 1.6x1.6 Thin MLF [®]
MIC5321-1.8/1.8YMT	MIC5321-GGYMT	BGG	1.8V/1.8V	-40°C to +125°C	6-Pin 1.6x1.6 Thin MLF [®]
MIC5321-1.8/1.6YMT	MIC5321-GWYMT	BGW	1.8V/1.6V	-40°C to +125°C	6-Pin 1.6x1.6 Thin MLF [®]
MIC5321-2.5/1.8YMT	MIC5321-JGYMT	BJG	2.5V/1.8V	-40°C to +125°C	6-Pin 1.6x1.6 Thin MLF [®]
MIC5321-2.5/2.5YMT	MIC5321-JJYMT	BJJ	2.5V/2.5V	-40°C to +125°C	6-Pin 1.6x1.6 Thin MLF [®]
MIC5321-2.6/1.85YMT	MIC5321-KDYMT	BKD	2.6V/1.85	-40°C to +125°C	6-Pin 1.6x1.6 Thin MLF [®]
MIC5321-2.6/1.8YMT	MIC5321-KGYMT	BKG	2.6V/1.8V	-40°C to +125°C	6-Pin 1.6x1.6 Thin MLF [®]
MIC5321-2.7/2.7YMT	MIC5321-LLYMT	BLL	2.7V/2.7V	-40°C to +125°C	6-Pin 1.6x1.6 Thin MLF [®]
MIC5321-2.8/1.5YMT	MIC5321-MFYMT	BMF	2.8V/1.5V	-40°C to +125°C	6-Pin 1.6x1.6 Thin MLF [®]
MIC5321-2.8/1.8YMT	MIC5321-MGYMT	BMG	2.8V/1.8V	-40°C to +125°C	6-Pin 1.6x1.6 Thin MLF [®]
MIC5321-2.8/2.6YMT	MIC5321-MKYMT	BMK	2.8V/2.6V	-40°C to +125°C	6-Pin 1.6x1.6 Thin MLF [®]
MIC5321-2.8/2.8YMT	MIC5321-MMYMT	BMM	2.8V/2.8V	-40°C to +125°C	6-Pin 1.6x1.6 Thin MLF [®]
MIC5321-2.85/1.85YMT	MIC5321-NDYMT	BND	2.85V/1.85V	-40°C to +125°C	6-Pin 1.6x1.6 Thin MLF [®]
MIC5321-2.85/2.6YMT	MIC5321-NKYMT	BNK	2.85V/2.6V	-40°C to +125°C	6-Pin 1.6x1.6 Thin MLF [®]
MIC5321-2.85/2.85YMT	MIC5321-NNYMT	BNN	2.85V/2.85V	-40°C to +125°C	6-Pin 1.6x1.6 Thin MLF [®]
MIC5321-2.9/1.5YMT	MIC5321-OFYMT	BOF	2.9V/1.5V	-40°C to +125°C	6-Pin 1.6x1.6 Thin MLF [®]
MIC5321-2.9/1.8YMT	MIC5321-OGYMT	BOG	2.9V/1.8V	-40°C to +125°C	6-Pin 1.6x1.6 Thin MLF [®]
MIC5321-2.9/2.9YMT	MIC5321-OOYMT	BOO	2.9V/2.9V	-40°C to +125°C	6-Pin 1.6x1.6 Thin MLF [®]
MIC5321-3.0/1.8YMT	MIC5321-PGYMT	BPG	3.0V/1.8V	-40°C to +125°C	6-Pin 1.6x1.6 Thin MLF [®]
MIC5321-3.0/2.5YMT	MIC5321-PJYMT	BPJ	3.0V/2.5V	-40°C to +125°C	6-Pin 1.6x1.6 Thin MLF [®]
MIC5321-3.0/2.6YMT	MIC5321-PKYMT	BPK	3.0V/2.6V	-40°C to +125°C	6-Pin 1.6x1.6 Thin MLF [®]
MIC5321-3.0/2.8YMT	MIC5321-PMYMT	BPM	3.0V/2.8V	-40°C to +125°C	6-Pin 1.6x1.6 Thin MLF [®]
MIC5321-3.0/2.85YMT	MIC5321-PNYMT	BPN	3.0V/2.85V	-40°C to +125°C	6-Pin 1.6x1.6 Thin MLF [®]
MIC5321-3.0/3.0YMT	MIC5321-PPYMT	BPP	3.0V/3.0V	-40°C to +125°C	6-Pin 1.6x1.6 Thin MLF [®]
MIC5321-3.3/1.5YMT	MIC5321-SFYMT	BSF	3.3V/1.5V	-40°C to +125°C	6-Pin 1.6x1.6 Thin MLF [®]
MIC5321-3.3/1.8YMT	MIC5321-SGYMT	BSG	3.3V/1.8V	-40°C to +125°C	6-Pin 1.6x1.6 Thin MLF [®]
MIC5321-3.3/2.5YMT	MIC5321-SJYMT	BSJ	3.3V/2.5V	-40°C to +125°C	6-Pin 1.6x1.6 Thin MLF [®]
MIC5321-3.3/2.6YMT	MIC5321-SKYMT	BSK	3.3V/2.6V	-40°C to +125°C	6-Pin 1.6x1.6 Thin MLF [®]
MIC5321-3.3/2.7YMT	MIC5321-SLYMT***	BSL	3.3V/2.7V	-40°C to +125°C	6-Pin 1.6x1.6 Thin MLF [®]
MIC5321-3.3/2.8YMT	MIC5321-SMYMT	BSM	3.3V/2.8V	-40°C to +125°C	6-Pin 1.6x1.6 Thin MLF [®]
MIC5321-3.3/2.85YMT	MIC5321-SNYMT	BSN	3.3V/2.85V	-40°C to +125°C	6-Pin 1.6x1.6 Thin MLF [®]
MIC5321-3.3/2.9YMT	MIC5321-SOYMT	BSO	3.3V/2.9V	-40°C to +125°C	6-Pin 1.6x1.6 Thin MLF [®]
MIC5321-3.3/3.0YMT	MIC5321-SPYMT	BSP	3.3V/3.0V	-40°C to +125°C	6-Pin 1.6x1.6 Thin MLF [®]
MIC5321-3.3/3.2YMT	MIC5321-SRYMT	BSR	3.3V/3.2V	-40°C to +125°C	6-Pin 1.6x1.6 Thin MLF [®]
MIC5321-3.3/3.3YMT	MIC5321-SSYMT	BSS	3.3V/3.3V	-40°C to +125°C	6-Pin 1.6x1.6 Thin MLF [®]
MIC5321-2.8/1.5YML	MIC5321-MFYML	$\overline{\text{BMF}}$	2.8V/1.5V	-40°C to +125°C	6-Pin 1.6x1.6 MLF [®]
MIC5321-2.8/1.8YML	MIC5321-MGYML	$\overline{\text{BMG}}$	2.8V/1.8V	-40°C to +125°C	6-Pin 1.6x1.6 MLF [®]
MIC5321-2.8/2.8YML	MIC5321-MMYML	$\overline{\text{BMM}}$	2.8V/2.8V	-40°C to +125°C	6-Pin 1.6x1.6 MLF [®]
MIC5321-3.0/3.0YML	MIC5321-PPYML	$\overline{\text{BPP}}$	3.0V/3.0V	-40°C to +125°C	6-Pin 1.6x1.6 MLF [®]

Part number	Manufacturing Part Number	Marking*	Voltage**	Junction Temp. Range	Package
MIC5321-1.8/1.5YD6	MIC5321-GFYD6	<u>QBGF</u>	1.8V/1.5V	-40°C to +125°C	6-Pin TSOT-23
MIC5321-1.8/1.8YD6	MIC5321-GGYD6	<u>QBGG</u>	1.8V/1.8V	-40°C to +125°C	6-Pin TSOT-23
MIC5321-1.8/1.6YD6	MIC5321-GWYD6***	<u>QBGW</u>	1.8V/1.6V	-40°C to +125°C	6-Pin TSOT-23
MIC5321-2.5/1.8YD6	MIC5321-JGYD6***	<u>QBJG</u>	2.5V/1.8V	-40°C to +125°C	6-Pin TSOT-23
MIC5321-2.5/2.5YD6	MIC5321-JJYD6***	<u>QBJJ</u>	2.5V/2.5V	-40°C to +125°C	6-Pin TSOT-23
MIC5321-2.6/1.85YD6	MIC5321-KDYD6***	<u>QBKD</u>	2.6V/1.85	-40°C to +125°C	6-Pin TSOT-23
MIC5321-2.6/1.8YD6	MIC5321-KGYD6***	<u>QBKG</u>	2.6V/1.8V	-40°C to +125°C	6-Pin TSOT-23
MIC5321-2.7/2.7YD6	MIC5321-LLYD6	<u>QBLL</u>	2.7V/2.7V	-40°C to +125°C	6-Pin TSOT-23
MIC5321-2.8/1.5YD6	MIC5321-MFYD6	<u>QBMF</u>	2.8V/1.5V	-40°C to +125°C	6-Pin TSOT-23
MIC5321-2.8/1.8YD6	MIC5321-MGYD6	<u>QBMG</u>	2.8V/1.8V	-40°C to +125°C	6-Pin TSOT-23
MIC5321-2.8/2.6YD6	MIC5321-MKYD6	<u>QBMK</u>	2.8V/2.6V	-40°C to +125°C	6-Pin TSOT-23
MIC5321-2.8/2.8YD6	MIC5321-MMYD6	<u>QBMM</u>	2.8V/2.8V	-40°C to +125°C	6-Pin TSOT-23
MIC5321-2.85/1.85YD6	MIC5321-NDYD6***	<u>QBND</u>	2.85V/1.85V	-40°C to +125°C	6-Pin TSOT-23
MIC5321-2.85/2.6YD6	MIC5321-NKYD6***	<u>QBNK</u>	2.85V/2.6V	-40°C to +125°C	6-Pin TSOT-23
MIC5321-2.85/2.85YD6	MIC5321-NNYD6***	<u>QBNN</u>	2.85V/2.85V	-40°C to +125°C	6-Pin TSOT-23
MIC5321-2.9/1.5YD6	MIC5321-OFYD6***	<u>QBOF</u>	2.9V/1.5V	-40°C to +125°C	6-Pin TSOT-23
MIC5321-2.9/1.8YD6	MIC5321-OGYD6***	<u>QBOG</u>	2.9V/1.8V	-40°C to +125°C	6-Pin TSOT-23
MIC5321-2.9/2.9YD6	MIC5321-OOYD6***	<u>QBOO</u>	2.9V/2.9V	-40°C to +125°C	6-Pin TSOT-23
MIC5321-3.0/1.8YD6	MIC5321-PGYD6	<u>QBPG</u>	3.0V/1.8V	-40°C to +125°C	6-Pin TSOT-23
MIC5321-3.0/2.5YD6	MIC5321-PJYD6***	<u>QBPJ</u>	3.0V/2.5V	-40°C to +125°C	6-Pin TSOT-23
MIC5321-3.0/2.6YD6	MIC5321-PKYD6***	<u>QBPK</u>	3.0V/2.6V	-40°C to +125°C	6-Pin TSOT-23
MIC5321-3.0/2.8YD6	MIC5321-PMYD6***	<u>QBPM</u>	3.0V/2.8V	-40°C to +125°C	6-Pin TSOT-23
MIC5321-3.0/2.85YD6	MIC5321-PNYD6***	<u>QBPN</u>	3.0V/2.85V	-40°C to +125°C	6-Pin TSOT-23
MIC5321-3.0/3.0YD6	MIC5321-PPYD6	<u>QBPP</u>	3.0V/3.0V	-40°C to +125°C	6-Pin TSOT-23
MIC5321-3.3/1.5YD6	MIC5321-SFYD6***	<u>QBSF</u>	3.3V/1.5V	-40°C to +125°C	6-Pin TSOT-23
MIC5321-3.3/1.8YD6	MIC5321-SGYD6***	<u>QBSG</u>	3.3V/1.8V	-40°C to +125°C	6-Pin TSOT-23
MIC5321-3.3/2.5YD6	MIC5321-SJYD6	<u>QBSJ</u>	3.3V/2.5V	-40°C to +125°C	6-Pin TSOT-23
MIC5321-3.3/2.6YD6	MIC5321-SKYD6***	<u>QBSK</u>	3.3V/2.6V	-40°C to +125°C	6-Pin TSOT-23
MIC5321-3.3/2.7YD6	MIC5321-SLYD6***	<u>QBSL</u>	3.3V/2.7V	-40°C to +125°C	6-Pin TSOT-23
MIC5321-3.3/2.8YD6	MIC5321-SMYD6***	<u>QBSM</u>	3.3V/2.8V	-40°C to +125°C	6-Pin TSOT-23
MIC5321-3.3/2.85YD6	MIC5321-SNYD6***	<u>QBSN</u>	3.3V/2.85V	-40°C to +125°C	6-Pin TSOT-23
MIC5321-3.3/2.9YD6	MIC5321-SOYD6***	<u>QBSO</u>	3.3V/2.9V	-40°C to +125°C	6-Pin TSOT-23
MIC5321-3.3/3.0YD6	MIC5321-SPYD6***	<u>QBSP</u>	3.3V/3.0V	-40°C to +125°C	6-Pin TSOT-23
MIC5321-3.3/3.2YD6	MIC5321-SRYD6***	<u>QBSR</u>	3.3V/3.2V	-40°C to +125°C	6-Pin TSOT-23
MIC5321-3.3/3.3YD6	MIC5321-SSYD6	<u>QBSS</u>	3.3V/3.3V	-40°C to +125°C	6-Pin TSOT-23

Notes

* Under bar ()/Over bar ($\bar{$) symbol may not be to scale. Thin MLF (MT) package Pin 1 identified = \blacktriangle .

** For other voltages available. Contact Micrel for more details.

*** Contact Micrel Marketing for availability.

Pin Configuration

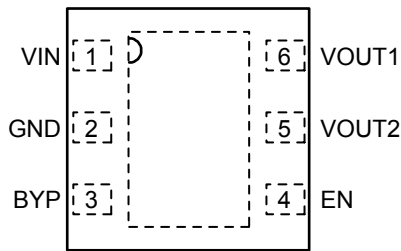

**6-Pin 1.6mm x 1.6mm Thin MLF (MT) / MLF (ML)
Top View**

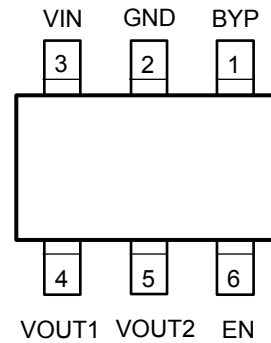

**TSOT-23-6 (D6)
Top View**

Pin Description

Pin Number Thin MLF-6 / MLF-6	Pin Number TSOT-23-6	Pin Name	Pin Function
1	3	VIN	Supply Input.
2	2	GND	Ground
3	1	BYP	Reference Bypass: Connect external 0.01 μ F to GND to reduce output noise. May be left open.
4	6	EN	Enable Input (both regulators): Active High Input. Logic High = On; Logic Low = Off; Do not leave floating.
5	5	VOUT2	Regulator Output – LDO2
6	4	VOUT1	Regulator Output – LDO1
HS Pad	–	EPAD	Exposed heatsink pad connected to ground internally.

Absolute Maximum Ratings⁽¹⁾

Supply Voltage (V_{IN})	0V to +6V
Enable Input Voltage (V_{EN})	0V to +6V
Power Dissipation	Internally Limited ⁽³⁾
Lead Temperature (soldering, 3sec)	260°C
Storage Temperature (T_S)	-65°C to +150°C
ESD Rating ⁽⁴⁾	2kV

Operating Ratings⁽²⁾

Supply Voltage (V_{IN})	+2.3V to +5.5V
Enable Input Voltage (V_{EN})	0V to V_{IN}
Junction Temperature (T_J)	-40°C to +125°C
Junction Thermal Resistance	
Thin MLF-6 / MLF-6 (θ_{JA})	100°C/W
TSOT-6 (θ_{JA})	235°C/W

Electrical Characteristics⁽⁵⁾

$V_{IN} = EN = V_{OUT} + 1.0V$; higher of the two regulator outputs, $I_{OUTLDO1} = I_{OUTLDO2} = 100\mu A$; $C_{OUT1} = C_{OUT2} = 1\mu F$; $C_{BYP} = 0.01\mu F$; $T_J = 25^\circ C$, **bold** values indicate $-40^\circ C \leq T_J \leq +125^\circ C$, unless noted.

Parameter	Conditions	Min	Typ	Max	Units
Output Voltage Accuracy	Variation from nominal V_{OUT}	-2.0		+2.0	%
	Variation from nominal V_{OUT} ; $-40^\circ C$ to $+125^\circ C$	-3.0		+3.0	%
Line Regulation	$V_{IN} = V_{OUT} + 1V$ to 5.5V; $I_{OUT} = 100\mu A$		0.02	0.3 0.6	%/V %/V
Load Regulation	$I_{OUT} = 100\mu A$ to 150mA		0.5	2.0	%
Dropout Voltage ⁽⁶⁾	$I_{OUT} = 100\mu A$		0.1		mV
	$I_{OUT} = 50mA$		12	50	mV
	$I_{OUT} = 100mA$		25	75	mV
	$I_{OUT} = 150mA$		35	100	mV
Ground Current	EN = High; $I_{OUT1} = 150mA$, $I_{OUT2} = 150mA$		150	190	μA
Ground Current in Shutdown	EN1 $\leq 0.2V$		0.01	2	μA
Ripple Rejection	f = 1kHz; $C_{OUT} = 1.0\mu F$; $C_{BYP} = 0.1\mu F$		75		dB
	f = 20kHz; $C_{OUT} = 1.0\mu F$; $C_{BYP} = 0.1\mu F$		45		dB
Current Limit	$V_{OUT} = 0V$	300	550	950	mA
Output Voltage Noise	$C_{OUT} = 1.0\mu F$; $C_{BYP} = 0.01\mu F$; 10Hz to 100kHz		30		μV_{RMS}
Enable Inputs (EN)					
Enable Input Voltage	Logic Low			0.2	V
	Logic High	1.1			V
Enable Input Current	$V_{IL} \leq 0.2V$		0.01	1	μA
	$V_{IH} \geq 1.0V$		0.01	1	μA
Turn-on Time (See Timing Diagram)					
Turn-on Time (LDO1 and 2)	$C_{OUT} = 1.0\mu F$; No C_{BYP}		40	100	μs
	$C_{OUT} = 1.0\mu F$; $C_{BYP} = 0.01\mu F$		45	100	μs

Notes:

- Exceeding the absolute maximum rating may damage the device.
- The device is not guaranteed to function outside its operating rating.
- The maximum allowable power dissipation of any T_A (ambient temperature) is $P_{D(max)} = (T_{J(max)} - T_A) / \theta_{JA}$. Exceeding the maximum allowable power dissipation will result in excessive die temperature, and the regulator will go into thermal shutdown.
- Devices are ESD sensitive. Handling precautions recommended. Human body model, 1.5k in series with 100pF.
- Specification for packaged product only.
- Dropout voltage is defined as the input-to-output differential at which the output voltage drops 2% below its nominal V_{OUT} . For outputs below 2.3V, the dropout voltage is the input-to-output differential with the minimum input voltage 2.3V

Functional Diagram

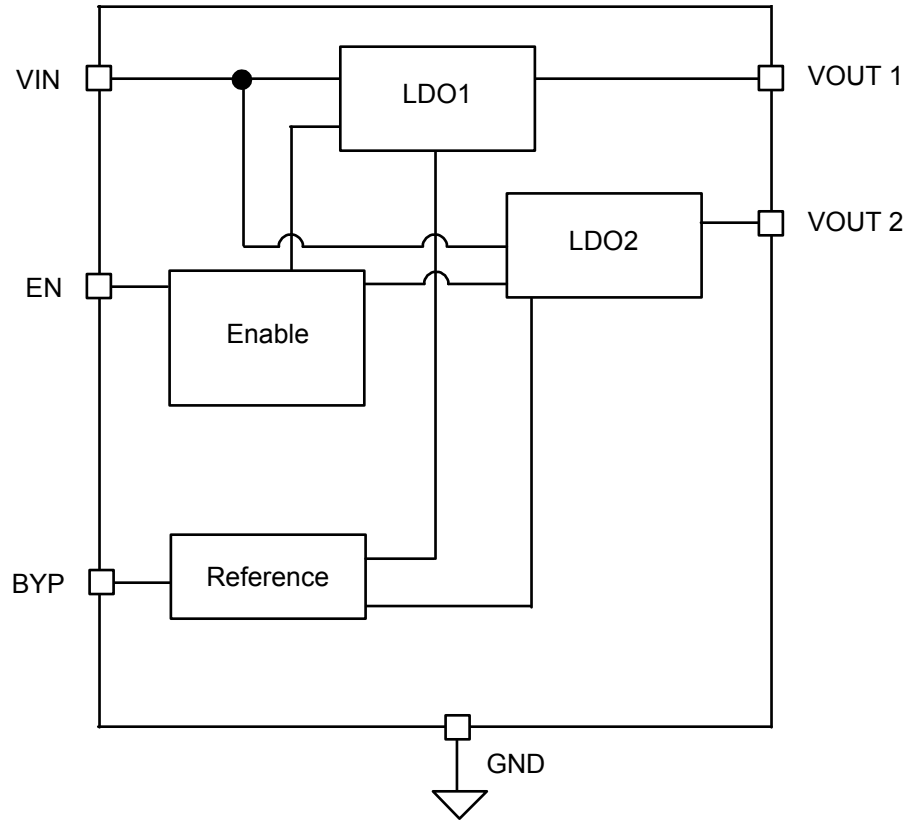

MIC5321 Block Diagram

Typical Characteristics

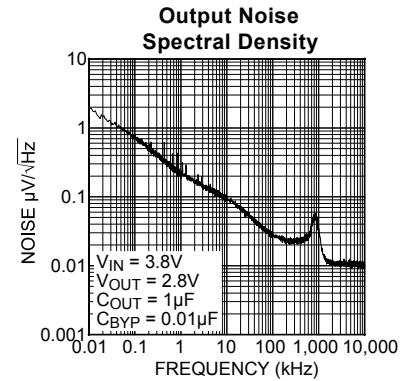
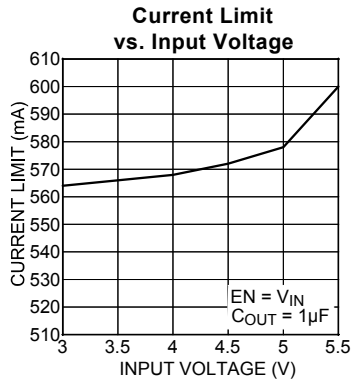
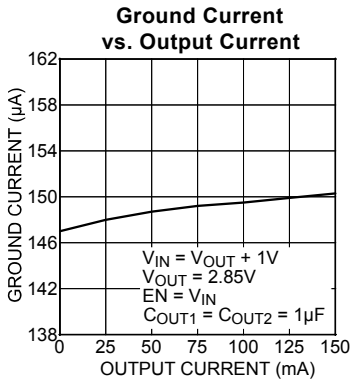
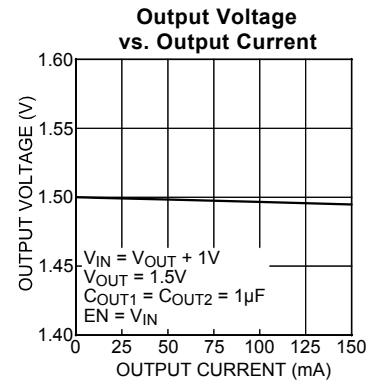
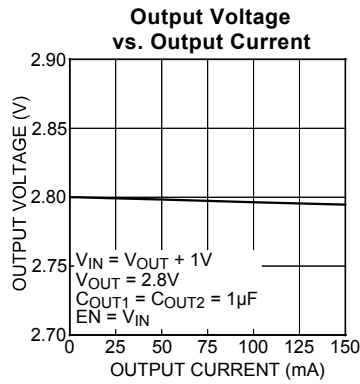
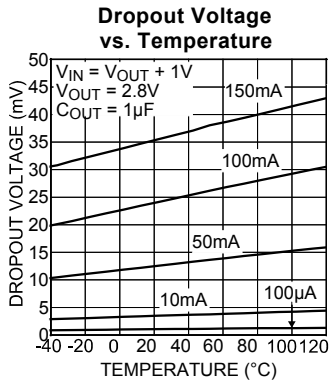
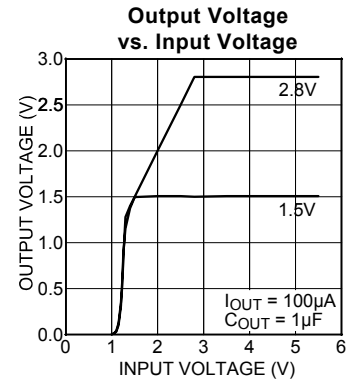
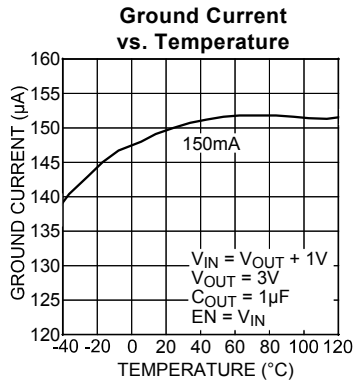
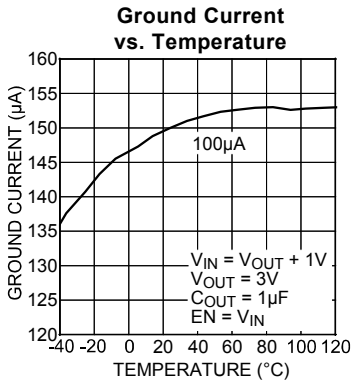
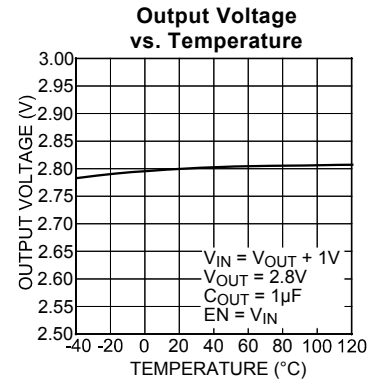
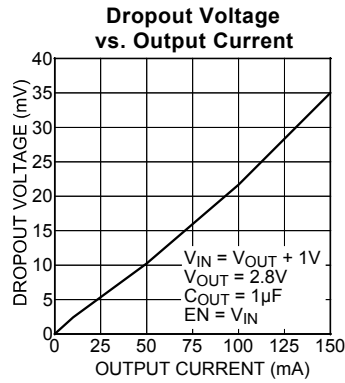
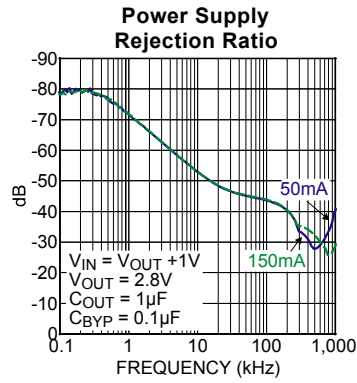

Functional Characteristics

Enable Turn-On

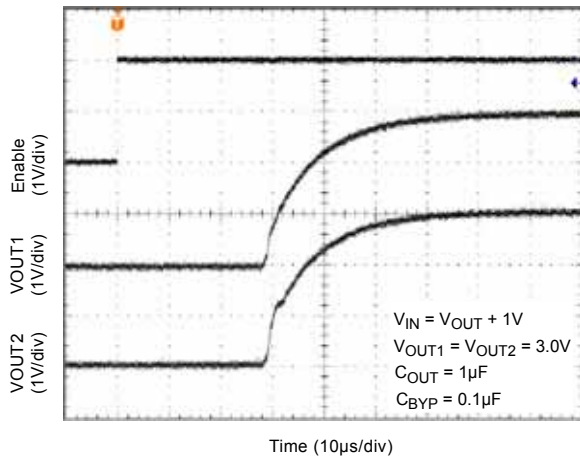

Load Transient

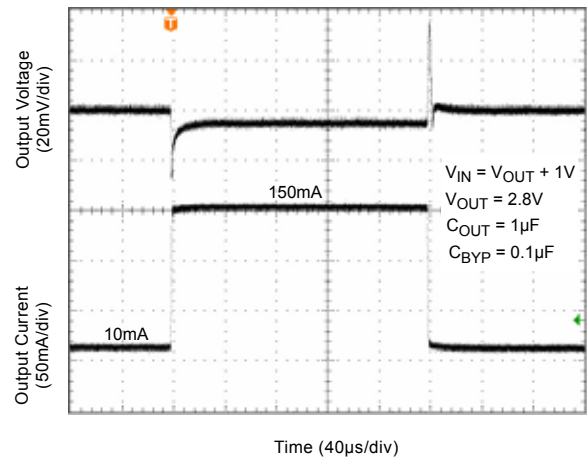

Line Transient

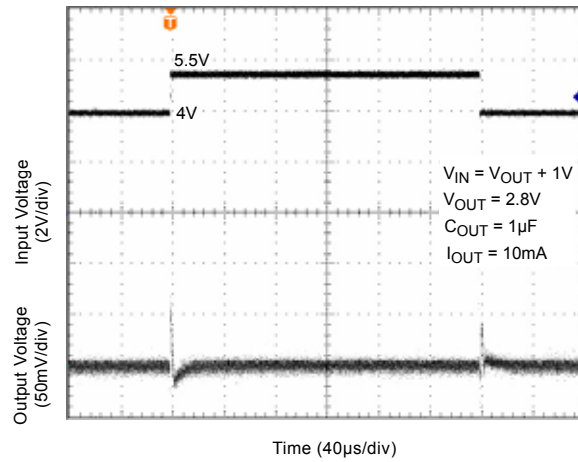

Applications Information

Enable/Shutdown

The MIC5321 comes with a single active-high enable pin that allows both regulators to be disabled simultaneously. Forcing the enable pin low disables the regulator and sends it into a “zero” off-mode-current state. In this state, current consumed by the regulator goes nearly to zero. Forcing the enable pin high enables the output voltage. The active-high enable pin uses CMOS technology and the enable pin cannot be left floating; a floating enable pin may cause an indeterminate state on the output.

Input Capacitor

The MIC5321 is a high-performance, high bandwidth device. Therefore, it requires a well-bypassed input supply for optimal performance. A 1 μ F capacitor is required from the input to ground to provide stability. Low-ESR ceramic capacitors provide optimal performance at a minimum of space. Additional high-frequency capacitors, such as small-valued NPO dielectric-type capacitors, help filter out high-frequency noise and are good practice in any RF-based circuit.

Output Capacitor

The MIC5321 requires an output capacitor of 1 μ F or greater to maintain stability. The design is optimized for use with low-ESR ceramic chip capacitors. High ESR capacitors may cause high frequency oscillation. The output capacitor can be increased, but performance has been optimized for a 1 μ F ceramic output capacitor and does not improve significantly with larger capacitance.

X7R/X5R dielectric-type ceramic capacitors are recommended because of their temperature performance. X7R-type capacitors change capacitance by 15% over their operating temperature range and are the most stable type of ceramic capacitors. Z5U and Y5V dielectric capacitors change value by as much as 50% and 60%, respectively, over their operating temperature ranges. To use a ceramic chip capacitor with Y5V dielectric, the value must be much higher than an X7R ceramic capacitor to ensure the same minimum capacitance over the equivalent operating temperature range.

Bypass Capacitor

A capacitor can be placed from the noise bypass pin to ground to reduce output voltage noise. The capacitor bypasses the internal reference. A 0.1 μ F capacitor is recommended for applications that require low-noise outputs. The bypass capacitor can be increased, further reducing noise and improving

PSRR. Turn-on time increases slightly with respect to bypass capacitance. A unique, quick-start circuit allows the MIC5321 to drive a large capacitor on the bypass pin without significantly slowing turn-on time. Refer to the Typical Characteristics section for performance with different bypass capacitors.

No-Load Stability

Unlike many other voltage regulators, the MIC5321 will remain stable and in regulation with no load. This is especially important in CMOS RAM keep-alive applications.

Thermal Considerations

The MIC5321 is designed to provide 150mA of continuous current for both outputs in a very small package. Maximum ambient operating temperature can be calculated based on the output current and the voltage drop across the part. Given that the input voltage is 3.3V, the output voltage is 2.8V for V_{OUT1} , 2.5V for V_{OUT2} and the output current = 150mA. The actual power dissipation of the regulator circuit can be determined using the equation:

$$P_D = (V_{IN} - V_{OUT1}) I_{OUT1} + (V_{IN} - V_{OUT2}) I_{OUT2} + V_{IN} I_{GND}$$

Because this device is CMOS and the ground current is typically <150 μ A over the load range, the power dissipation contributed by the ground current is < 1% and can be ignored for this calculation.

$$P_D = (3.3V - 2.8V) \times 150mA + (3.3V - 1.5V) \times 150mA \\ P_D = 0.345W$$

To determine the maximum ambient operating temperature of the package, use the junction-to-ambient thermal resistance of the device and the following basic equation:

$$P_{D(MAX)} = \left(\frac{T_{J(MAX)} - T_A}{\theta_{JA}} \right)$$

$T_{J(max)} = 125^\circ\text{C}$, the maximum junction temperature of the die θ_{JA} thermal resistance = 100 $^\circ\text{C/W}$.

The table below shows junction-to-ambient thermal resistance for the MIC5321 in the Thin MLF[®] package.

Package	θ_{JA} Recommended Minimum Footprint	θ_{JC}
6-Pin 1.6x1.6 Thin MLF [®]	100 $^\circ\text{C/W}$	2 $^\circ\text{C/W}$

Thermal Resistance

Substituting P_D for $P_{D(max)}$ and solving for the ambient operating temperature will give the maximum operating conditions for the regulator circuit. The junction-to-ambient thermal resistance for the minimum footprint is $100^{\circ}\text{C}/\text{W}$.

The maximum power dissipation must not be exceeded for proper operation.

For example, when operating the MIC5321-MFYMT at an input voltage of 3.3V and 150mA loads at each output with a minimum footprint layout, the maximum ambient operating temperature T_A can be determined as follows:

$$0.345\text{W} = (125^{\circ}\text{C} - T_A)/(100^{\circ}\text{C}/\text{W})$$

$$T_A = 90.5^{\circ}\text{C}$$

Therefore, a 2.8V/1.5V application with 150mA at each output current can accept an ambient operating temperature of 90.5°C in a 1.6mm x 1.6mm Thin MLF[®] package. For a full discussion of heat sinking and thermal effects on voltage regulators, refer to the "Regulator Thermals" section of *Micrel's Designing with Low-Dropout Voltage Regulators* handbook. This information can be found on Micrel's website at:

http://www.micrel.com/_PDF/other/LDOBk_ds.pdf

Package Information

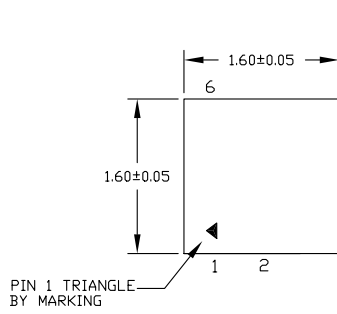

TOP VIEW

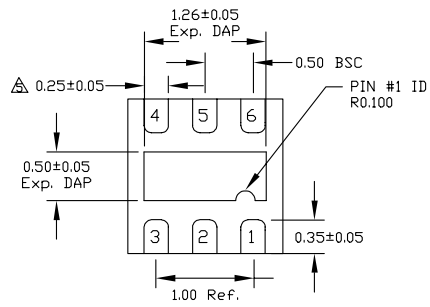

BOTTOM VIEW

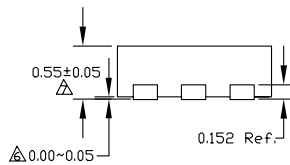

SIDE VIEW

- NOTE:
1. ALL DIMENSIONS ARE IN MILLIMETERS.
 2. MAX. PACKAGE WARPAGE IS 0.05 mm.
 3. MAXIMUM ALLOWABLE BURRS IS 0.076 mm IN ALL DIRECTIONS.
 4. PIN #1 ID ON TOP WILL BE LASER/INK MARKED.
- △ DIMENSION APPLIES TO METALIZED TERMINAL AND IS MEASURED BETWEEN 0.20 AND 0.25 mm FROM TERMINAL TIP.
- △ APPLIED ONLY FOR TERMINALS.
- △ APPLIED FOR EXPOSED PAD AND TERMINALS.

6-Pin 1.6mm x 1.6mm Thin MLF (MT)

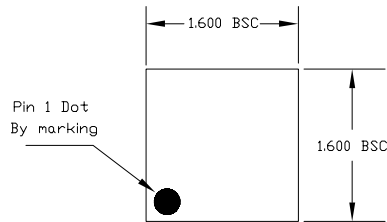

TOP VIEW

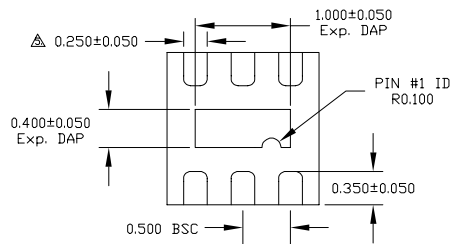

BOTTOM VIEW

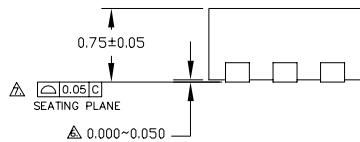

SIDE VIEW

- NOTE:
1. ALL DIMENSIONS ARE IN MILLIMETERS.
 2. MAX. PACKAGE WARPAGE IS 0.05 mm.
 3. MAXIMUM ALLOWABLE BURRS IS 0.076 mm IN ALL DIRECTIONS.
 4. PIN #1 ID ON TOP WILL BE LASER/INK MARKED.
- △ DIMENSION APPLIES TO METALIZED TERMINAL AND IS MEASURED BETWEEN 0.20 AND 0.25 mm FROM TERMINAL TIP.
- △ APPLIED ONLY FOR TERMINALS.
- △ APPLIED FOR EXPOSED PAD AND TERMINALS.

6-Pin 1.6mm x 1.6mm MLF (ML)

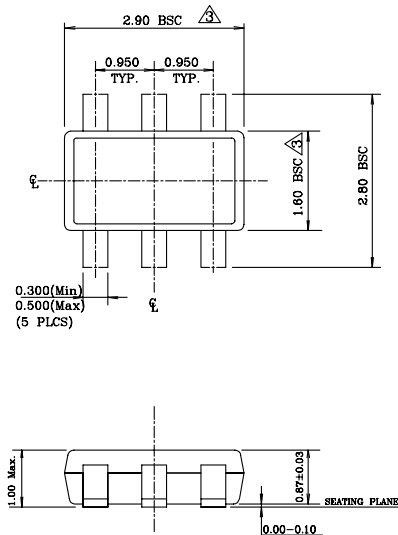

NOTE:

1. Dimensions and tolerances are as per ANSI Y14.5M, 1994.
2. Die is facing up for mold. Die is facing down for trim/form, ie. reverse trim/form.
3. Dimensions are exclusive of mold flash and gate burr.
4. The footlength measuring is based on the gauge plane method.
5. All specification comply to Jedec Spec M0193 Issue C.
6. All dimensions are in millimeters.

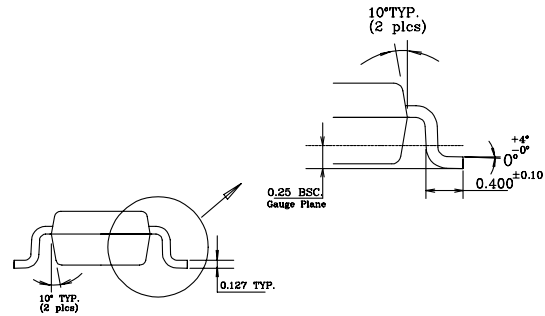

6-Pin TSOT-23 (D6)

MICREL, INC. 2180 FORTUNE DRIVE SAN JOSE, CA 95131 USA
 TEL +1 (408) 944-0800 FAX +1 (408) 474-1000 WEB <http://www.micrel.com>

The information furnished by Micrel in this data sheet is believed to be accurate and reliable. However, no responsibility is assumed by Micrel for its use. Micrel reserves the right to change circuitry and specifications at any time without notification to the customer.

Micrel Products are not designed or authorized for use as components in life support appliances, devices or systems where malfunction of a product can reasonably be expected to result in personal injury. Life support devices or systems are devices or systems that (a) are intended for surgical implant into the body or (b) support or sustain life, and whose failure to perform can be reasonably expected to result in a significant injury to the user. A Purchaser's use or sale of Micrel Products for use in life support appliances, devices or systems is a Purchaser's own risk and Purchaser agrees to fully indemnify Micrel for any damages resulting from such use or sale.

© 2006 Micrel, Inc.